



Winperfil Avant
Version for PC and
desktop systems



Winperfil App
Version for mobile
and desktop devices



The best solution
for your company

Informative Dossier

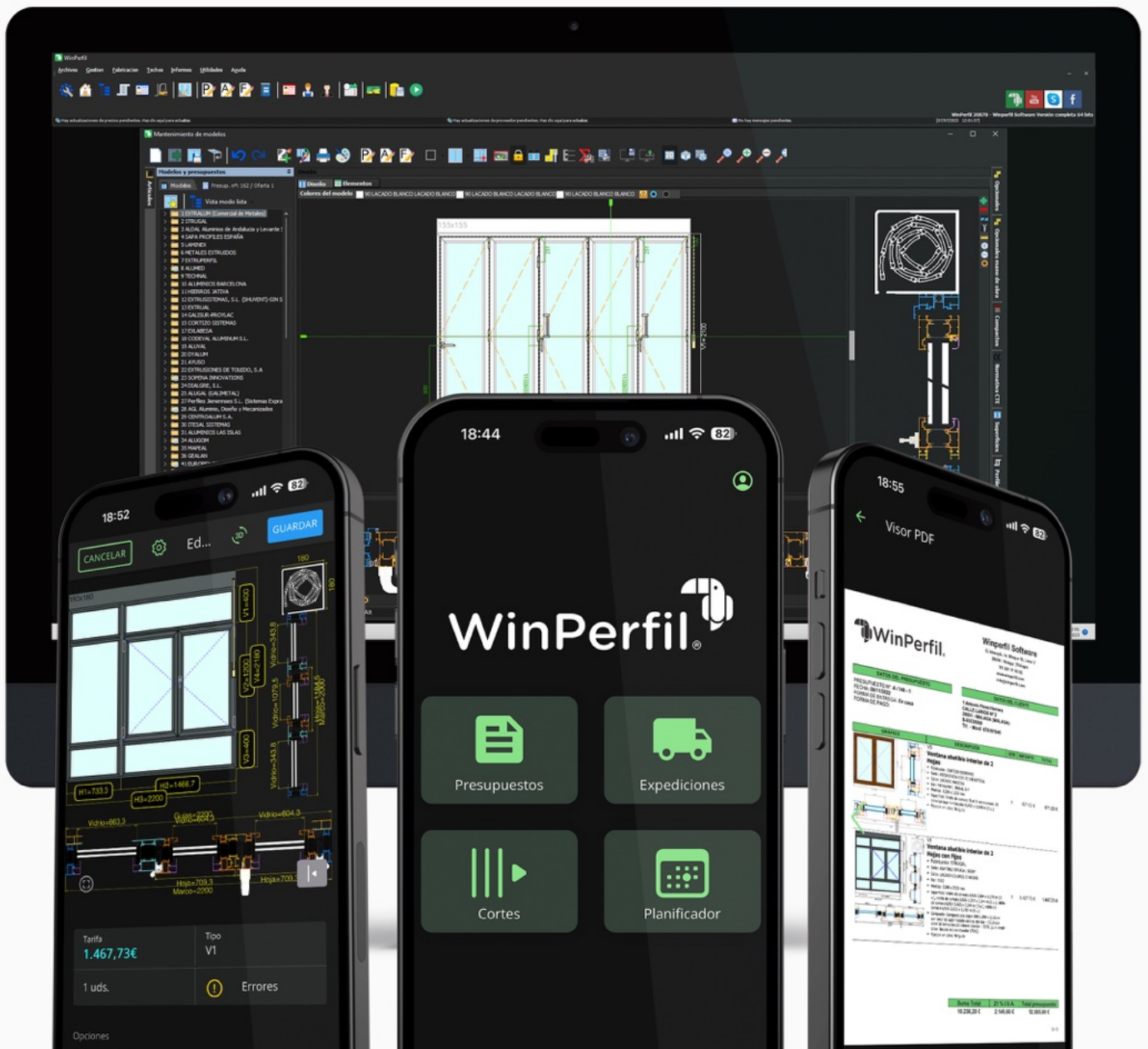



First of all, **THANK YOU** for your interest in our product.

Throughout this document, we will detail all the information you need to know about the Software and to evaluate the different modules the program offers, analyzing what your needs are.

With our years of experience, Winperfil works day by day to advance with new projects and offer a quality service that adapts to the needs of each of the companies that are part of our client portfolio.

Who are we?

Winperfil Software is a leading Spanish company that markets the most comprehensive program for the aluminum, PVC, and tempered glass enclosure industry, with almost 30 years of experience in the sector. Over all these years, we have computerized large companies in this sector that endorse our experience and professionalism.

The main purposes of Winperfil lie in continuous evolution, always maintaining an innovative and up-to-date product that meets the needs of a constantly changing sector and in a quality technical service that provides its clients with solid support to facilitate the adaptation and learning of an increasingly comprehensive product.

We are aware that the most important thing is customer service and satisfaction, which is why we have a limitless service where you can make any type of inquiry, attended to by the team immediately.

The software provides a complete tool for carpenters and suppliers of aluminum and PVC. We have the largest database of manufacturers on the market with more than 50 configured and ready-to-use suppliers.

A user-friendly 2D and 3D design system that will make daily work a fast and reliable process. Our program allows you to design freely without any type of restriction. Have a program that does not limit your daily work in any way.

Another basic and necessary point for a program like this is to stay updated and much better if it is done automatically. Our software updates the databases when a supplier includes a new series, discontinues an old one, or modifies an element.

It also updates automatically when a supplier changes the price rates. The software version also updates automatically with all the new options we develop in our programming department.

As you can see, Winperfil is committed to customer satisfaction and spares no effort to achieve it, making it a well-established company proud to have many satisfied customers.

The head office is located in Málaga, and you can find our contact details at the following web address:

www.winperfil.com/contacto/

Program Features

Our program covers all the needs of any metalworking shop.

First, we have a powerful tool for designing windows and doors that allows you to use hundreds of pre-designed models in the database, make modifications to them, save them for future use without having to redo the design process, create new doors and windows with complete freedom, and store them in the database through an extremely intuitive process. It also includes all the design and structural calculation for curtain walls and windows through an expert that makes it faster and easier to create.

We are the fastest software for curtain walls on the market.

With Winperfil, you can have complete and thorough control over the management of your company. The program covers all aspects of your business, from a budget manager that allows you to create quotes quickly and easily, a complete optimization engine for workshop and supplier orders. It offers total control of your company's accounting and management thanks to the modules for delivery notes, invoices, treasury, banks, management of collections and payments, and the possibility of linking with Contaplus or any other program you use (under a personalized budget).

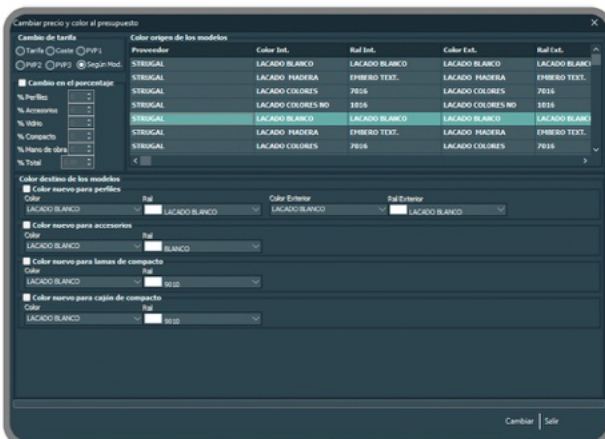

Change of price and color of an offer.

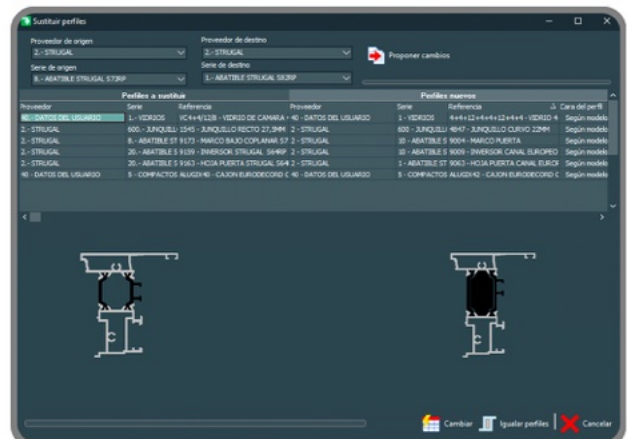

Change of profiles and glass in an offer.

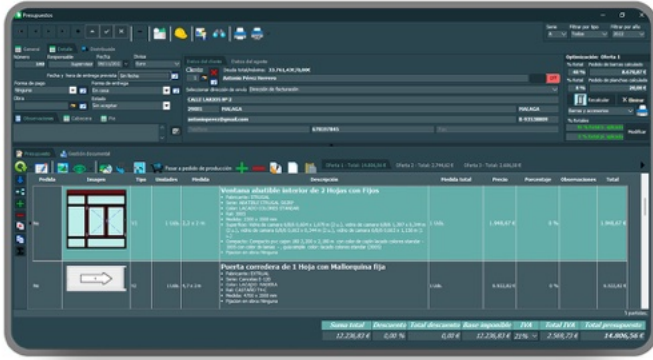

Budget with multiple quotes



Monitor the status of budgets, orders, cuts, etc.

Below are some of the main features of our software:

Configurable budget descriptions:

This allows for the automated configuration of budget descriptions.

Various options let you select the font type, size, style, and color, as well as the information to display, enabling you to have fully customized budgets.



Budget form with model image



Budget form with multiple images

Multi-language document generation:

Thus, all these budgets can be printed in another language - Spanish, English, French, and Portuguese - automatically.



Production Manager

This allows you to organize workshop work and manufacturing easily while instantly checking material availability. Additionally, planning through a calendar ensures meeting delivery deadlines without difficulty. Along these lines, this option allows you to maximize the use of your transportation fleet by distributing material among your different trucks and obtaining the most efficient route for each one.

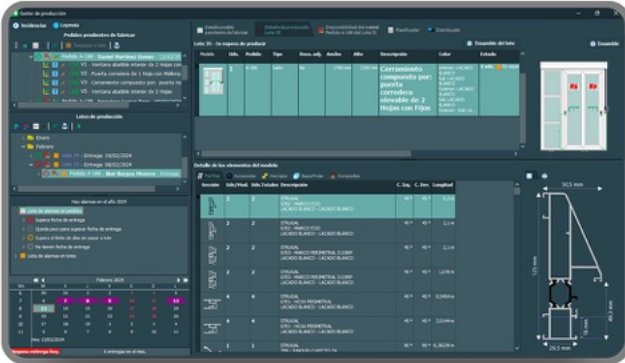

Production manager detail

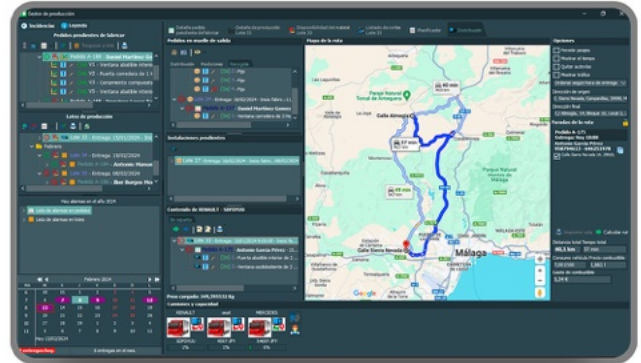

Distribution manager detail

Click on the images to see the production manager demo video

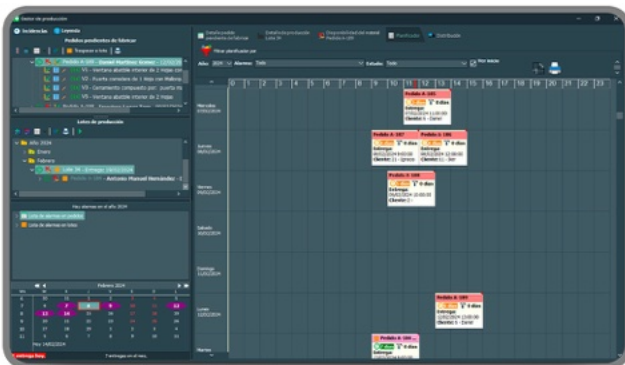

Planner manager detail

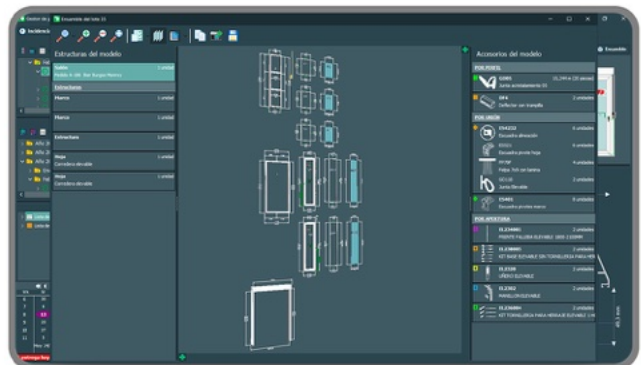

Batch assembly detail in the manager

Customer Orders, Order Phases, and Manufacturing Status

With this option, the user can coordinate the various accepted offers to control the different statuses of their budgets. Thus, associated documents with clarifications for management or manufacturing, such as contracts, notes, photographs, etc., can be added. The system supports Word, Excel, PDF, and AutoCAD formats in this case.

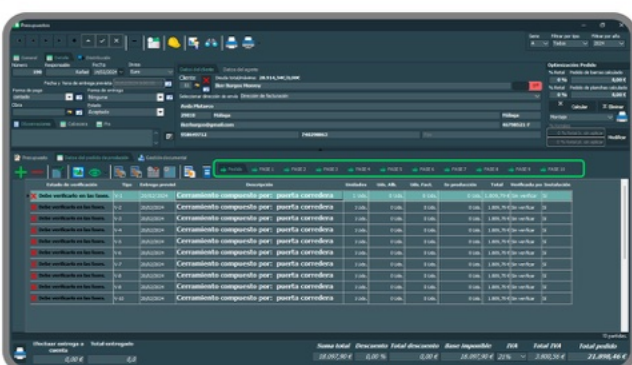

Phases within a single order

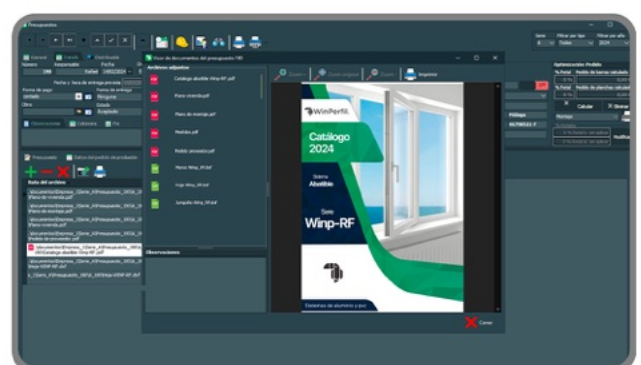

Associated documents

Foldable Systems

Currently, foldable systems are the best way to achieve airtight enclosures, with the possibility of covering large spaces for our home or commercial facades. You can create designs with different opening combinations using various precise tools that allow us to configure both the correct leaf measurements and the optimal hardware calculation based on dimensions and the number of leaves, with the ability to visualize them in our 3D design.

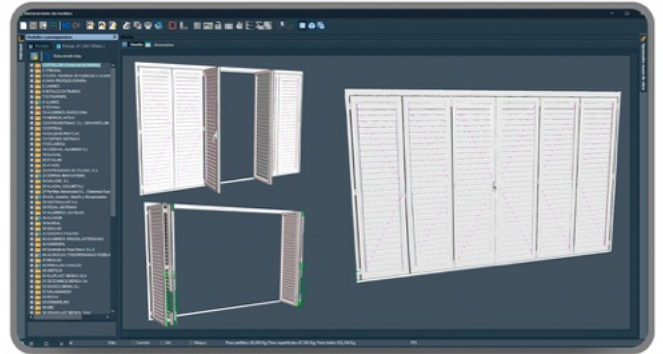
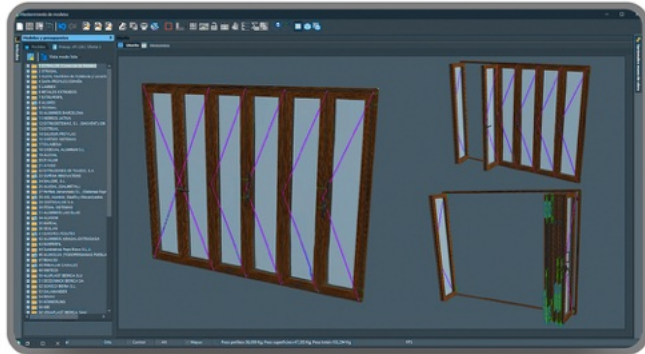

Click on the image to see the foldable systems demo video

Balustrading System

Glass has become the main feature of new balustrade to fully enjoy the landscape. We can recreate the final result and see the glass anchored to the profiles and their gaskets, even performing operations such as drilling, etc. Not forgetting the classic balustrade with tubes and handrails.

Click on the image to see the balustrades demo video

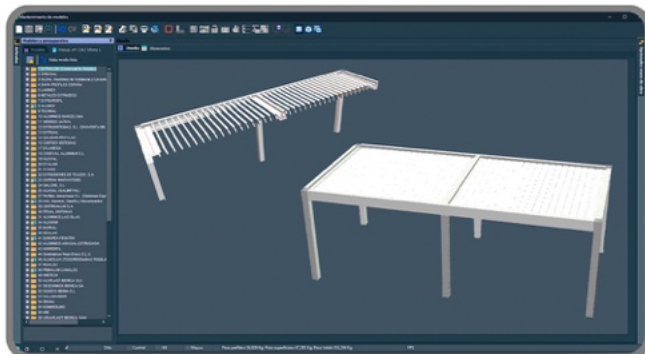
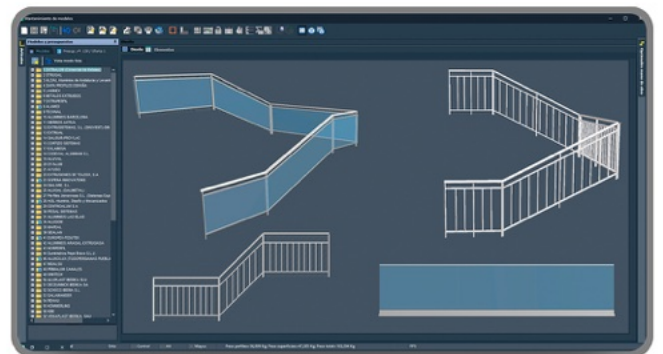

Pergolas

Winperfil also helps you design the most efficient spaces for your clients, such as the outdoor sun protection systems, like bioclimatic pergolas. These sophisticated and efficient systems cater to the needs of residential terraces or any commercial space, addressing energy requirements and the use of spaces of any size and need.

Click on the image to see the pergolas demo video

Doors

Our 3D system allows us to showcase different openings to present the most sophisticated door designs, such as large-sized pivot opening systems, showing the final result to the client, including glass surfaces or decorative panels.

Click on the image to see the doors demo video

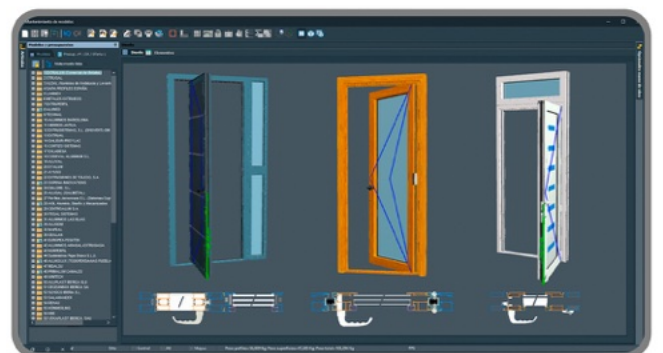

3D Warehouse

In this regard, the system offers everything necessary for warehouse management. It includes a three-dimensional graphic designer that provides a realistic representation with the exact location of materials within the warehouse. This facilitates the quick and visual location of different items, saving time and speeding up the control and use of available stock.

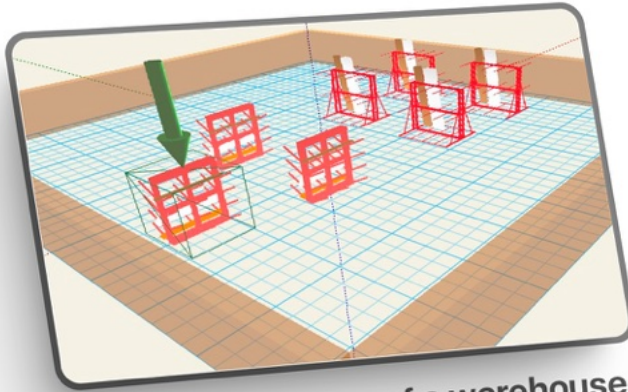

3D representation of a warehouse with stands and material location indicator

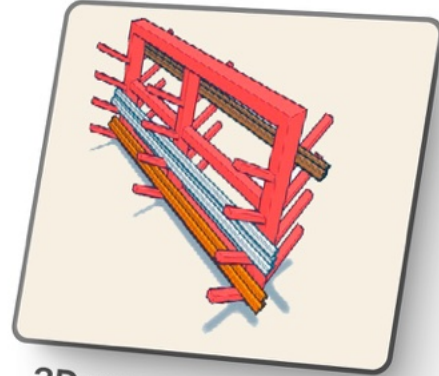

3D representation of a warehouse stand

Click on the images to see the warehouse demo video

Online Multi-language Video Help

New online video help is always updated and accessible with an Internet connection, eliminating the need to download large files and the slow execution of external programs. It allows easy access to the complete library of help videos organized by categories. The videos are also available in English, French, and Portuguese.

Ayuda en video

Haz clic sobre la categoría para acceder a la biblioteca de videos

NOVEDADES

WinPerfil

MÓDULOS

WinPerfil

GENERAL

WinPerfil

TUTORIALES NIVEL BÁSICO

WinPerfil

TUTORIALES NIVEL MEDIO

WinPerfil

TUTORIALES NIVEL EXPERTO

WinPerfil

Aviso Legal Política de Privacidad Política de Cookies Configuración de Cookies

Novedades

< Volver al menú principal



Gestionar y tratar el lacado/anodado de perfiles



Tutorial de Facturación: Definir la numeración en facturas para el nuevo año



Nuevas opciones en la gestión de colores en proveedores



Nuevas opciones en la visualización de calendarios



Nueva opción para duplicar un pedido manual de proveedor



Nuevo informe compactos y mecanizado recibidos/serie embudada

Fixed, Mobile Roofs, and Glass Curtain

Here, through an expert, you can quickly and easily design and budget roofs, obtaining a three-dimensional image of the model and all the necessary elements as well as their corresponding prices.

Click on the image to see the roof demo video



This module also includes the tools and features for designing and managing the calculation of machining distances to achieve efficient production of the glass curtain.

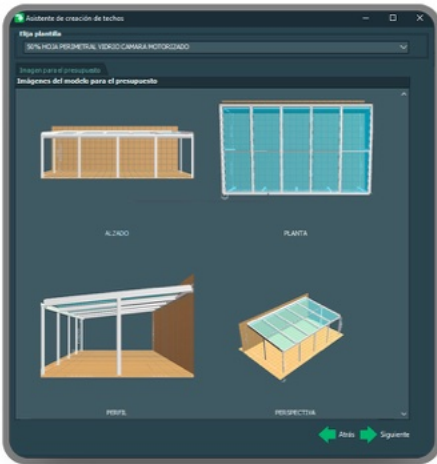

Model images in the roof creation assistant

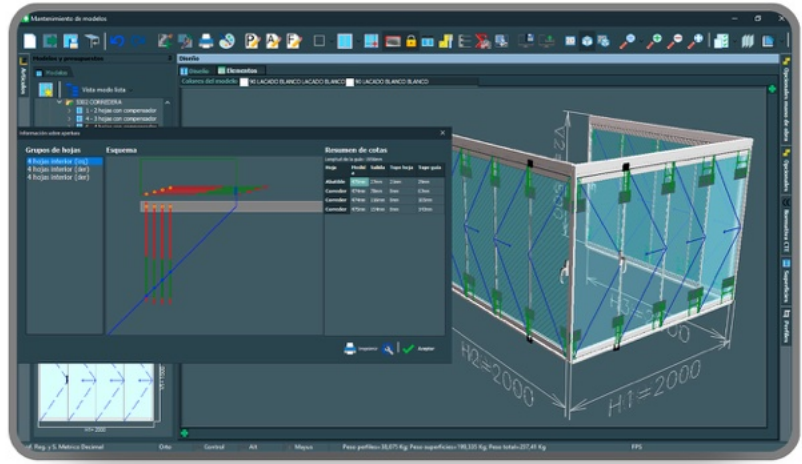
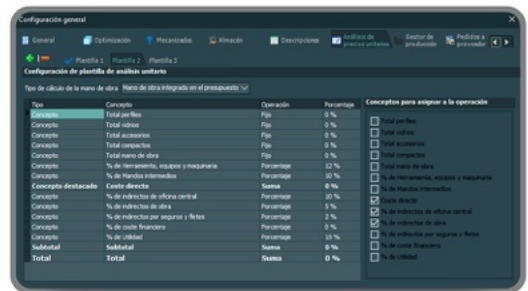

Diagram and information on openings in glass curtain models

Click on the image to see the glass curtain demo video

Unit analysis cost card

A new option for unit cost analysis, configurable through simple and intuitive templates by the user. With this option, you can apply direct or indirect costs to your items in a personalized manner.



Surface Optimization

In addition to the existing bar optimization, this new version incorporates surface optimization to include offcuts in the active budget and reduce surface preparation time.

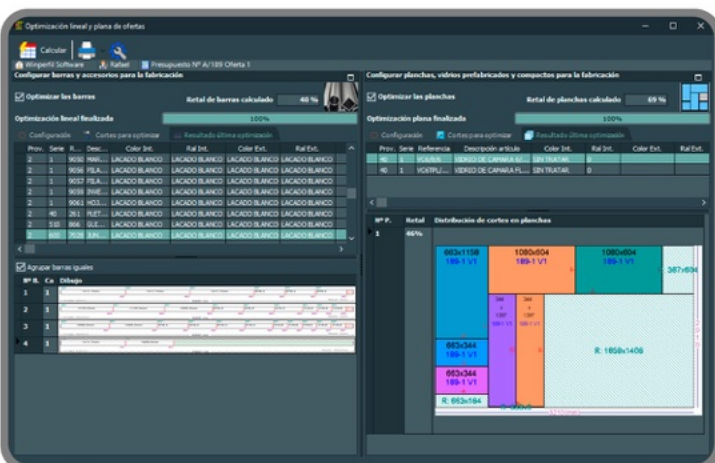

Linear and flat optimization



Sheet cutting report

Customizable Interface

Allows the user to reduce the learning and handling time of the program by configuring the appearance of its updated, intuitive, and improved graphical interface. It also includes new color styles so you can adapt the software to your liking.

Click on the image to see the demo video

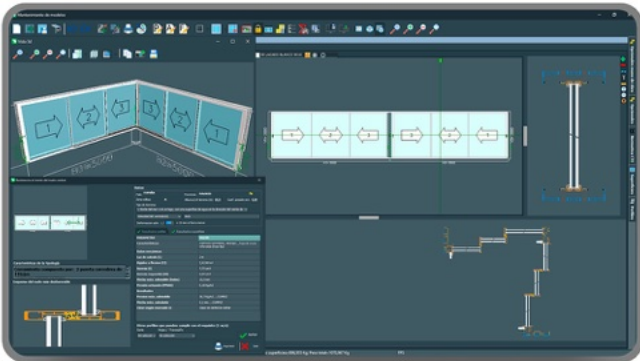

Full view of the design window

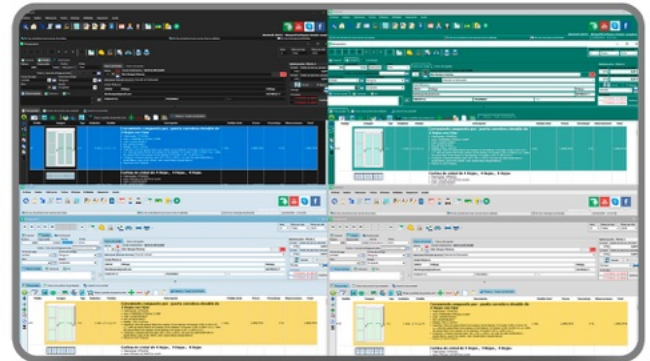

Choose and customize the software with the new color styles

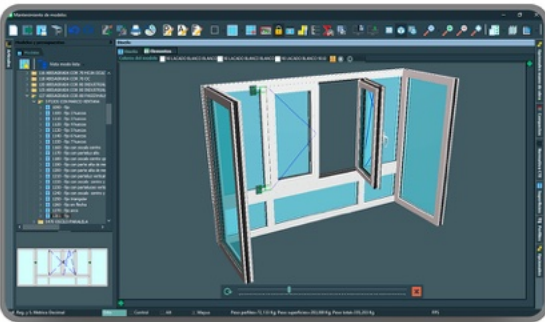

New 3D Engine

The new 3D graphics engine will further enhance the design experience significantly, allowing for more precise and fluid control of different models and items.

Click on the image to see the demo video

Curtain Walls, Structural, Semi-structural, and Capped

With the help of an expert, the user will have the option to easily and automatically budget all types of walls. This includes considering all necessary elements such as surfaces, fastenings, mullions, transoms, openings, and cuts, among others. The result will be the wall itself along with its structural calculation.

Click on the image to see the curtain wall demo video

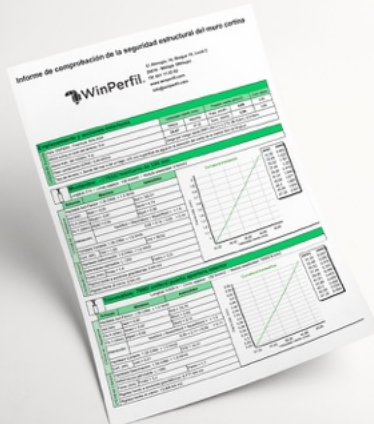

Structural safety check report



View of a capped curtain wall with structural calculation

The structural calculation option for facades, doors, and windows shows the maximum wind pressure supported by the central joint of the model. It determines external actions and calculates loads, stresses, and deformations, all in accordance with current regulations. Additionally, it checks special elements such as glass and connection pieces of the model to the main structure of the building and, consequently, informs the validity of the profiles, also providing the possibility to correct them instantly.

Machine Connection

Using a modern and powerful yet simple editor, the user can manage and handle machining data, as well as perform automatic importation of the different machinings involved in the hardware. This option guarantees immediate startup, reducing operating times.

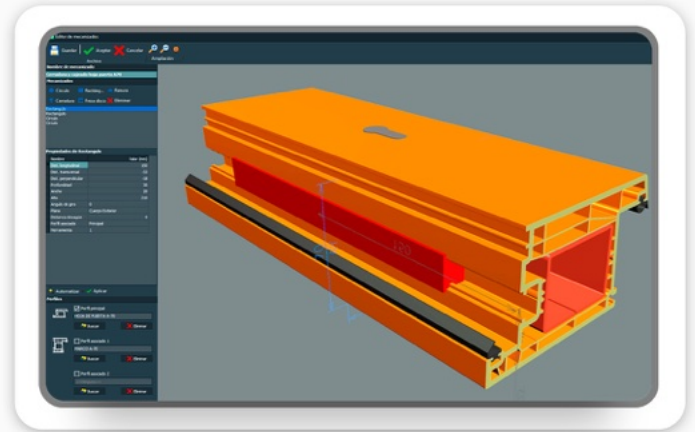

Program Demonstration

Besides being able to analyze and view numerous videos available on YouTube, we invite you to request an online and personalized demonstration of our program. In this demonstration, a technician will contact you and connect with you, showing you the program and addressing any questions you might still have about our product. Feel free to request the demonstration at the following email address: info@winperfil.com

Maintenance Service

At Winperfil, we understand that we are not all the same, so we adapt the program to each client.

The maintenance service you contract includes the following features:

- Technical support and training via Skype, with hours for Europe from 9:00 AM to 2:00 PM, except in case of a serious error that prevents you from working with the program, in which case an emergency service is available.
- Online training course for the program (it is essential to watch the tutorial videos sent after contracting to take the personalized training course).
- Configuration and customization of printouts with your company logo.
- Automatic price updates.
- Automatic updates from suppliers (new series, new items, etc.).
- Continuous program updates with new options and improvements at no additional cost.

100% Compatible with Windows 10 and 11

Fully functional version for Windows 10 and 11, taking advantage of all the benefits this new operating system offers: multitasking, touch interface, speed, and optimization.



WinPerfil App

With the new App, you can create your budgets from anywhere and deliver them instantly, without delays. And many more features.

What are you waiting for to try it out?

Compatible with all operating systems



[Click here](#) to watch the demonstration

Incredible Features

Voice-to-text to streamline your tasks



Everything you do in the App is in Avant. Instantly!

Total security of your data



Instantly share via email, whatsapp, etc. your reports

Easily calculate optimization



Create budgets wherever you are, from any part of the world!



Digital printing of all budget and production / workshop reports



Customer signature accepting the order

Realidad aumentada



 Winperfil Software

info@winperfil.com
(+34) 601 11 93 92
www.winperfil.com

[Click here](#) and stay up to date with all our latest developments

 Technical support via Skype:
• España/Portugal: winperfil1
• Latinoamérica: winperfil-consultas.mexico